



AMS001 / AMS002

Data Sheet



Disclaimer

While the information provided in this document is believed to be accurate, it is under development and ACKme Networks reserves the right to make changes without further notice to the product described herein to improve reliability, function, or design, and makes no guarantee or warranty concerning the accuracy of said information, nor shall it be responsible for any loss or damage of whatever nature resulting from the use of, or reliance upon, such information. ACKme Networks makes no warranties of any kind, whether express, implied or arising by custom or course of trade or performance, and specifically disclaims the implied warranties of title, non-infringement, merchantability, or fitness for a particular purpose.

No part of this document may be copied, reproduced, stored in a retrieval system, or transmitted, in any form or by any means, electronic, mechanical, photographic, or otherwise, or used as the basis for manufacture or sale of any items without the prior written consent of ACKme Networks.

Trademarks

ACKme Networks and the ACKme Networks logo are trademarks of ACKme Networks. WICED™ is a trademark of Broadcom® Corporation, Inc. Bluetooth® is a trademark of the Bluetooth SIG. Other trademarks in this document belong to their respective owners.

Copyright © 2014-2015 ACKme Networks.

All rights reserved.

Document Number: ADS-MS00x-107R

Release Date: September 14, 2015

Contact

<http://ack.me/contact>

About this Data Sheet

This document provides information on the family of AMS00x Bluetooth Low Energy (Bluetooth Smart) modules from ACKme Networks.

Organization

This data sheet is organized into the following sections:

- [Features & Applications](#)
- [General Description, Section 1](#)
- [Block Diagram, Section 2](#)
- [Electrical Specifications, Section 3](#)
- [Bluetooth RF Specifications, Section 4](#)
- [Pinout and Signal Descriptions, Section 5](#)
- [Design Guidelines, Section 6](#)
- [Regulatory Certification, Section 7](#)
- [Packaging, Handling & Storage, RoHS, Section 8](#)
- [Ordering Information, Section 9](#)
- [Revision History & Glossary, Section 11](#)

AMS00x Family Data Sheet

Embedded Bluetooth Low Energy Solution

Features

- Bluetooth Low Energy (Bluetooth Smart) modules fully certified to meet Bluetooth version 4.1.
- Integrated 8 Mbit SPI-serial flash supports firmware updates and multiple on-board applications
- On-board PCB-style antenna
- ARM® Cortex™ M3-based microprocessor core
- Adaptive Frequency Hopping (AFH)
- Programmable RF transmit power control
- Operation directly from a battery or mains supply
- Small size enables integration into most sensor products and applications
- Secure Over-the-Air (OTA) software update using industry-standard AES-128 security
- Easily integrated into existing or new products using TruConnect, ACKme's configurable Bluetooth Low Energy application (pre-installed on every module)
- Multiple services including ACKme TruConnect, Beacon, iBeacon, plus more ...

Interfaces*

- A/D converter: 7 channels with 4 modes providing variable resolution (10-13 ENOBs), sampling rate (5.9-187 kHz) and conversion latency (5-171 μ s)
- USART: 1 x 4-wire up to 1.5 Mbit/s for general use, 1 x 2-wire for in-circuit programming
- SPI: 1 x master, 1 x slave at \leq 12 Mbit/s
- I²C: 1 x I²C master interface up to 1 MHz
- GPIO: Up to 12 GPIOs (overlaid with peripherals), programmable pull-up/pull-down resistors with 16 mA drive strength at 3.3V (2 mA standard).
- 4 x PWM channels each with a 10-bit counter clocked at 128 kHz.
- Wake-up: Wake from GPIO for ultra-low power operation.

**Some interfaces share module pins*

Operational & Radio

- Operational voltage : 1.8V - 3.6V
- Operational Temperature Range: -30°C to +85°C
- Size : 17.6 x 11.4 x 2.4mm (0.70" x 0.45" x 0.10")
- Weight : 0.04 oz (1.2g)
- Current consumption @ 3.0V, 25°C
 - Deep Sleep : 1.65 μ A (typ.)
 - Sleep : 12 μ A
 - AMS001
 - Active Receive : 12.8 mA
 - Active Transmit : 10.8 mA
 - AMS002
 - Active Receive : 26.6 mA
 - Active Transmit : 22.0 mA
- RF Transmit Power: +4 dBm (max.)
- Receive Sensitivity : -94 dBm

Applications

- Health & Fitness
 - Fitness Equipment
 - Heart rate monitors
 - Weight scales
 - Thermometers
 - Pedometers
 - Glucose meters
 - Blood pressure monitoring
- Retail
 - Advertising and Beacons
 - Proximity detection
 - Point-of-sale
- Home & Industrial Control and Automation
 - Appliance control and monitoring
 - Doors/Window monitoring
 - Alarms
 - Wireless cable replacement
 - Environmental & Energy monitoring
 - Wireless sensing, remote data logging
- Consumer
 - Toys
 - Robots
 - Remote controls

Contents

1	General Description	1	7.1.1	Labeling and User Information Requirements.....	14
2	Block Diagram	2	7.1.2	RF Exposure	15
3	Electrical Specifications.....	3	7.1.3	External Antenna	15
3.1	Absolute Maximum Ratings.....	3	7.1.4	Further Information.....	15
3.2	Recommended Operating Conditions	3	7.2	Canada	15
3.2.1	DC Operating Conditions	3	7.2.1	Labeling and User Information Requirements.....	15
3.2.2	Environmental Conditions	4	7.2.2	External Antenna Types.....	16
3.3	Power Consumption	4	7.2.3	Further Information.....	16
3.4	Input/Output Pins.....	5	7.3	Europe	17
3.5	ADC Specifications	5	7.3.1	Labeling and User Information Requirements.....	17
4	Bluetooth RF Specifications	6	7.3.1	External Antenna Requirements	17
4.1	Summary RF Specifications.....	6	7.3.2	Further Information.....	17
4.2	Receiver Specifications	6	7.4	Australia.....	18
4.3	Transmitter Specifications	7	7.4.1	External Antenna Requirements	18
5	Pinout and Signal Descriptions	8	7.4.2	Further Information.....	18
5.1	Pinout.....	8	7.5	New Zealand	19
5.2	Pin Description.....	8	7.5.1	External Antenna Requirements	19
6	Design Guidelines.....	10	7.5.2	Further Information.....	19
6.1	Recommended PCB Footprint	10	8	Packaging, Handling & Storage, RoHS	20
6.2	Routing Recommendations	10	8.1	Packaging.....	20
6.3	Soldering Information.....	11	8.2	Tape and Reel Specifications	20
6.4	AMS00x Photograph.....	11	8.3	Handling & Storage.....	22
6.5	Application Examples.....	12	8.4	RoHS Directive	22
6.5.1	UART Application for Configuration and Streaming.....	12	9	Ordering Information.....	23
6.6	Operation using TruConnect	12	10	Revision History & Glossary	24
6.6.1	Bootup Configuration	12	10.1	Revision History	24
6.6.2	Factory Reset	13	10.2	Glossary	24
6.6.3	Command and Stream Mode	13			
6.6.4	GPIO Configuration & Usage	13			
7	Regulatory Certification	14			
7.1	United States	14			

1 General Description

The family of AMS00x 'Bobcat' modules from ACKme Networks is based on an ultra-low power Bluetooth Low Energy (Bluetooth Smart) SoC from Broadcom Corporation. All modules incorporate serial-flash memory and a printed antenna to provide a state-of-the-art fully-certified Bluetooth 4.1 solution.

An integrated solution avoids difficult RF layout and enables designers to rapidly embed Bluetooth Low Energy into virtually any device.

The AMS001 (Low Power) version slashes active power consumption for applications requiring multi-year battery life, while the AMS002 (Low Cost) version provides the lowest cost solution suitable for price sensitive applications. The modules are 100% footprint compatible.

Modules ship with ACKme TruConnect, an easy-to-use application enabling control and configuration via UART-serial and remote terminal interfaces. TruConnect virtually eliminates difficult and time-consuming software development effort and vastly reduces product development cycles.

With dimensions of just 17.6 x 11.4 mm, a wide temperature range, and an ultra-low power version, the module is suitable for integration into any battery-powered embedded wireless application.

The Bluetooth Low Energy SoC from Broadcom is purpose-designed to support the entire spectrum of Bluetooth Smart use cases for medical, home automation, accessory, sensor, retail and wearable market segments. Superior receive sensitivity, an integrated RF transmit power amplifier and transmit/receive switch, along with the on-board antenna, provide extended range and full compatibility with all Bluetooth 4.1 devices.

At the heart of all AMS00x modules is a Bluetooth Low Energy SoC with a high-performance ARM® 32-bit Cortex™-M3 core operating at a frequency of 24 MHz. The SoC includes is configured to boot applications stored in the 8 Mbit serial flash memory available on-board the module.

The Broadcom BLE SoC supports Adaptive Frequency Hopping.

Each module provides an extensive array of I/O and peripheral interfaces. The following interfaces are available, many of which are accessible with I/O multiplexing and alternate function capabilities:

7 x A/D converter channels

- 2 x UART interfaces: 1 x 4-wire, 1 x 2-wire
- 1 x SPI master, 1 x SPI slave bus
- 1 x I²C interface
- Up to 12 x ultra-low power wake input
- 32kHz crystal interface

The module may be powered directly from a battery supply in the range 1.8-3.6V including 2xAAA, 2xAA, or a single Lithium coin cell.

Internal power domains are automatically adjusted to minimize power dissipation based on user activity. Various power modes, including an ultra-low power deep sleep mode, are provided to minimize total average power consumption and maximize battery life.

Custom factory settings may be saved to a non-erasable area of static memory to enable out-of-the-box custom product configuration and the ability to return products incorporating the module to a known factory reset state.

The module may be woken from deep sleep mode by a level transition on the GPIO assigned for stream mode selection. Other GPIOs may be dynamically allocated for control and status including a BLE connection indicator, serial bus mode control and status indicator, audible alerts and factory reset.

An internal 32kHz low-power oscillator is available by default for non-critical timing requirements. Applications requiring an accurate real-time clock may connect an (optional) external 32kHz crystal.

All versions of the module have Bluetooth BQB SIG certification, and FCC & IC modular approval for use in the United States and Canada, and CE approval for use in Europe and other countries.

2 Block Diagram

Figure 1 is a block diagram showing the architecture of AMS00x Bluetooth Low Energy modules. The major components are a Bluetooth Low Energy SoC from Broadcom, 24MHz crystal, 8 Mbit serial flash and a PCB-style antenna. The AMS001 version also includes a high-efficiency DC-DC switching regulator to significantly reduce active mode power consumption.

The Bluetooth SoC is powered by an ARM Cortex M3-based processor running at 24 MHz. The SoC is driven by a 24 MHz crystal, an on-board real-time clock may be (optionally) enabled by connecting an external 32kHz crystal.

The 8 Mbit serial flash memory stores the ACKme TruConnect™ application and user configuration, and enables secure Over-the-Air (OTA) wireless firmware updates. The on-board PCB antenna simplifies RF integration into end products.

An extensive array of analog and digital peripherals including ADCs, GPIOs, PWMs and multiple serial interfaces such as UART, SPI and I2C are accessible via module pins.

The module is powered by a single-rail battery or mains supply.

Figure 1. AMS00x Architecture

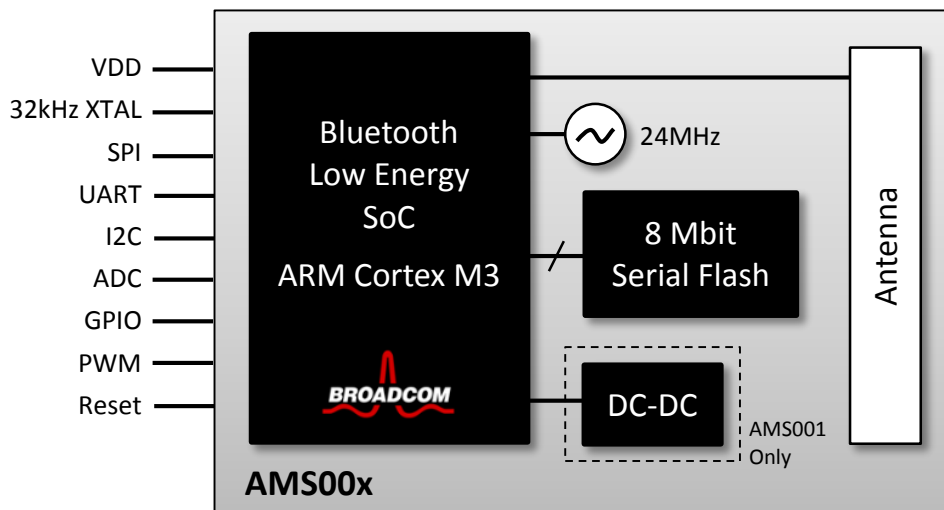

3 Electrical Specifications

3.1 Absolute Maximum Ratings

CAUTION! The absolute maximum ratings in Table 1 and Table 2 indicate levels where permanent damage to the device can occur, even if these limits are exceeded for only a brief duration. Functional operation is not guaranteed under these conditions. Operation at absolute maximum conditions for extended periods can adversely affect long-term reliability of the device.

Table 1. Absolute Maximum Voltage Ratings

Symbol	Ratings	Min.	Max.	Unit
VDD _{max}	DC supply voltage applied to VDD pin	GND - 0.3	3.8	V
V _{IO}	Voltage on input or output pin	GND - 0.3	VDD _{max} + 0.3	V

Table 2. Absolute Maximum Environmental Ratings

Characteristic	Note	Min.	Max.	Unit
Storage Temperature	–	-40	+125	°C
Relative Humidity	Non-condensing (storage)	–	65	%

3.2 Recommended Operating Conditions

Functional operation is not guaranteed outside the limits shown in Table 3 and Table 4, and operation outside these limits for extended periods can adversely affect long-term reliability of the device.

3.2.1 DC Operating Conditions

Table 3. Recommended DC Operating Conditions

Symbol	Ratings ¹	Min.	Typical	Max.	Unit
VDD	DC supply voltage applied to VDD pin				
	On-board serial flash read-only	1.8	–	3.63	V
	On-board serial flash read and write	2.1	–	3.63	V
	On-board serial flash at power-on	2.25 ²	–	3.63	V

Notes:

1. Overall performance degrades beyond minimum and maximum supply voltages.
2. The module may fail to boot if this condition is not met when power is initially applied.

3.2.2 Environmental Conditions

Table 4. Recommended Environmental Conditions

Characteristic	Note	Min.	Max.	Unit
Ambient Temperature		-30	+85	°C
Relative Humidity	Non-condensing (operating)	–	85	%

3.3 Power Consumption

The AMS00x automatically adjusts power dissipation based on user activity to minimize power usage. The power consumption in each state, and for each version of the module, is specified in Table 5.

Table 5. Power Consumption (3.0V, 25°C)

Operational State	Note	Typical	Unit
Deep sleep ¹	BLE Chip (0.65 μ A) + Serial Flash (1 μ A)	1.65	μ A
Sleep	Wake in <5ms	12.0	μ A
AMS001			
	Active Receive	Receiver enabled and operating at 100% duty cycle	12.8 mA
	Active Transmit ²	Transmitter enabled and operating at 100% duty cycle	10.8 mA
AMS002			
	Active Receive	Receiver enabled and operating at 100% duty cycle	26.6 mA
	Active Transmit ²	Transmitter enabled and operating at 100% duty cycle	22.0 mA

Notes:

1. Requires 10K pullup resistor on module pin 6. See 6.5.1, UART Application for Configuration and Streaming
2. RF transmit power = 0dBm

3.4 Input/Output Pins

All digital I/O pins have a maximum input voltage rating of $V_{SS}-0.3V$ to $V_{DD}+0.3V$.
The maximum supply voltage is 3.63V.

Consequently, digital I/O pins are NOT +5V tolerant.

Table 6. Digital I/O Pin Levels

Symbol	Description	Min.	Typical	Max.	Unit
V_{IL}	Input low voltage	–	–	0.4	V
V_{IH}	Input high voltage	$0.75 \times V_{DD}$	–	–	V
V_{OL}	Output low voltage ¹	–	–	0.4	V
V_{OH}	Output high voltage ¹	$V_{DD} - 0.4$	–	–	V

Notes:

1. At the specified drive current for the pin.

3.5 ADC Specifications

Table 7. ADC Specifications (@ 25°C)

Parameter	Symbol	Conditions	Min.	Typ.	Max.	Unit
Input Channels	–		–	8	–	–
Channel Switching Rate	f_{ch}		–	133.33	–	kch/s
Input signal range	V_{inp}		0	–	3.63	V
Reference settling time	–		7.5	–	–	μ S
Input resistance	R_{in}	Effective, single ended	–	500	–	k Ω
Input capacitance	C_{in}		–	–	5	pF
Conversion rate	R_c		5.859	–	187	kHz
Conversion time	T_c		5.35	–	170.7	μ S
Effective Number of Bits	ENOB		10	–	13	bits
Abs. Voltage Meas. Error	–		–	± 2	–	%
Current	I		–	–	1	mA
Leakage Current	$I_{leakage}$		–	–	100	nA
Power-up time	T_{pup}		–	–	200	μ S
Integral nonlinearity	I_{NL}	LSBs at the 10-bit level	-1	–	1	LSB
Differential nonlinearity	D_{NL}	LSBs at the 10-bit level	-1	–	1	LSB

4 Bluetooth RF Specifications

Unless otherwise stated, the specifications in this section apply when the operating conditions are within the limits specified in Section 3.2, Recommended Operating Conditions. Functional operation outside these limits is not guaranteed.

All specifications are measured with a coax pigtail soldered to the PCB antenna feed point, with VDD = 3.0V and at a room temperature of 25°C.

4.1 Summary RF Specifications

Table 8. Summary RF Specifications

Feature Supported	Description
Bluetooth Standard	Version 4.1
Frequency Band	2.400 GHz – 2.500 GHz
Channels (2MHz spacing)	3 x Advertising channels @ 2402 / 2426 / 2480 MHz 36 x Data channels
Maximum Raw Data Rate	1 Mbit/s
Maximum Application Data Rate	0.27 Mbit/s
Modulation Type	DSSS: GFSK (modulation index = 0.5)
Maximum RF Input	-10 dBm
Typical Receive Sensitivity	-94 dBm
Maximum RF Tx Output Power	+4 dBm
Carrier Frequency Accuracy	±20 ppm (24 MHz crystal, ±20 ppm stability @ 25°C)

4.2 Receiver Specifications

Table 9. Receiver Performance Specifications

Parameter	Condition/Notes	Min.	Typical	Max.	Unit
Frequency Range	–	2402	–	2480	MHz
Operating Temperature	–	-30	–	+85	°C
Receive Sensitivity	<i>200 x 37-byte packets with 30.8% PER</i>	–	-94	–	dBm
Maximum Receive Level		-10	–	–	dBm

4.3 Transmitter Specifications

Table 10. Transmitter Performance Specifications

Parameter	Condition/Notes	Min	Typical	Max	Unit
Frequency Range	–	2402	–	2480	MHz
Operating Temperature	–	-30	–	+85	°C
Transmit power ²	–	–	4.0	–	dBm
Transmit power variation	Process dependent	–	2.0	–	
Transmit Power Range	Adjustable via software control	-20		4	dBm
Channel Spacing		–	2	–	MHz

5 Pinout and Signal Descriptions

5.1 Pinout

A top view of the AMS00x pinout is depicted in Figure 2. All dimensions are in thousands of an inch. A recommended PCB footprint is provided in Section 6.1.

Figure 2. AMS00x Pinout (TOP View – Pins NOT visible from top!)

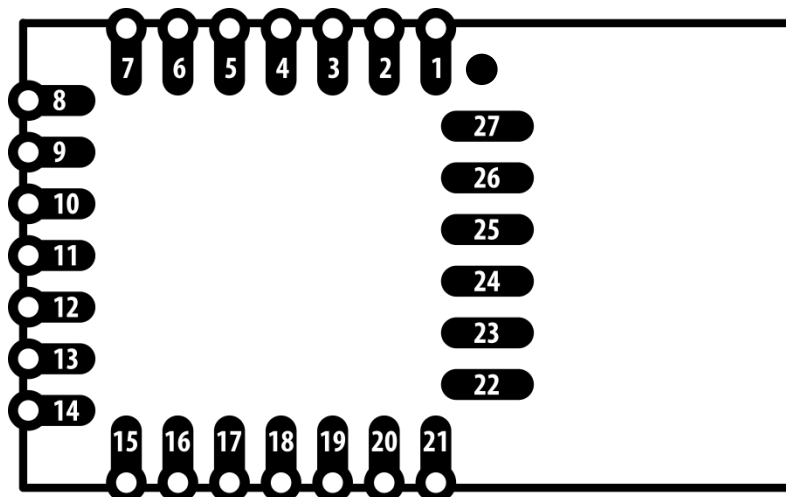

5.2 Pin Description

Table 11. AMS00x Pin Definitions

Pin	Name	Type ¹	Primary Function	Alternate & Other Function(s)
1	GND	S	Ground	-
2	PROG_RX	I	PROG RX	-
3	PROG_TX	O	PROG TX	-
4	GPIO_0	I/O	Reserved ⁴	Not available as digital I/O. Reserved for future use as SPI_MOSI, I2C_SDA
5	GPIO_1	I/O	Reserved ⁴	Not available as digital I/O. Reserved for future use as SPI_CLK, I2C_SCL
6	GPIO_2	I/O	USER TX	SPI_MOSI (Slave), ADC, GPIO
7	GPIO_3	I/O	USER_RTS	SPI_MISO (Slave), ADC. , GPIO
8	RESET_N	I	System Reset	-
9	GPIO_4	I/O	USER_CTS	SPI_CLK (Slave), GPIO
10	GPIO_5	I/O	USER_RX	SPI_CS (Slave), GPIO

Pin	Name	Type ¹	Primary Function	Alternate & Other Function(s)
11	GPIO_6	I/O	GPIO	SPI_MOSI (Master), FACTORY_RESET ³
12	GPIO_7	N/C	Reserved ⁴	Reserved. Not available as digital I/O
13	GPIO_8	I/O	GPIO	SPI_MISO (Master)
14	GPIO_9	I/O	GPIO	SPI_CLK (Master)
15	GPIO_10 ²	I/O	GPIO	ADC, PWM
16	GPIO_11	I/O	GPIO	ADC, PWM
17	GPIO_12	I/O	GPIO	SPI_CS (Master), ADC
18	GPIO_13 ²	I/O	GPIO	ADC, PWM, XOSC32_OUT
19	GND	S	Ground	-
20	GPIO_14 ²	I/O	GPIO	ADC, PWM, XOSC32K_IN
21	VDD	S	VDD	-
22-27	GND	S	Ground	-

Notes:

1. I = Input, O = Output, S = Supply
2. The drive strength of standard GPIOs is 2mA, the drive strength of this GPIO is 16mA.
3. The FACTORY_RESET pin may be moved to a different GPIO, but it may not be de-assigned
4. Connected to SPI serial flash inside the module

6 Design Guidelines

6.1 Recommended PCB Footprint

All dimensions in Figure 3 are in thousands of an inch unless otherwise marked.

Figure 3. AMS00x Recommended Footprint (Top)

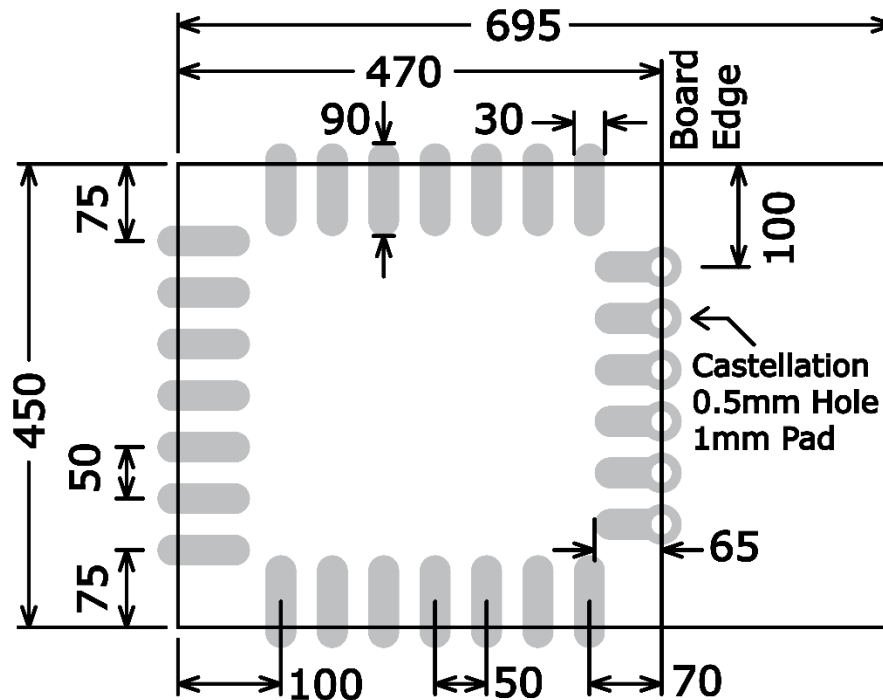

6.2 Routing Recommendations

When designing a carrier board, the addition of ground fill directly underneath the module, rather than signal or power traces, is strongly advised.

All ground pads adjacent to antenna pins must be connected to a solid ground plane. Do not route ANY metal or PCB traces underneath the printed PCB-antenna!

Failure to comply with these recommendations will almost certainly result in degraded performance of the radio receiver and/or transmitter.

For optimal range, provide a clearance of 5mm (0.2") above, below and to the front and sides of the antenna end of the module.

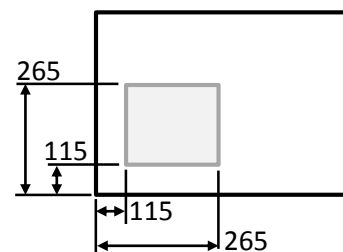

Avoid routing traces not connected to ground under the vias in the shaded rectangle.

Measurements are in thousandths of an inch.

6.3 Soldering Information

Figure 4. Recommended solder reflow profile

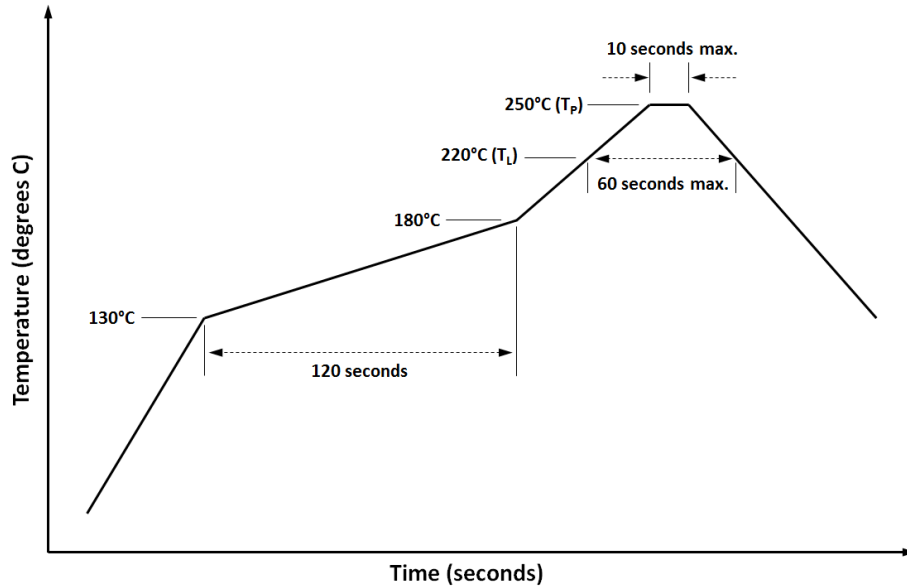

6.4 AMS00x Photograph

Figure 5. AMS00x Photograph (Top)



6.5 Application Examples

6.5.1 UART Application for Configuration and Streaming

Follow the schematic in Figure 6 to connect a host MCU UART to the User UART serial interface of the AMS00x module. This application enables a host MCU to configure the module using command mode, and transfer data back and forth to a remote device via the Bluetooth LE wireless interface using stream mode. UART hardware flow control is not required, but is recommended for streaming continuous data.

Figure 6. Connecting a Host MCU to the AMS001/AMS002 User UART

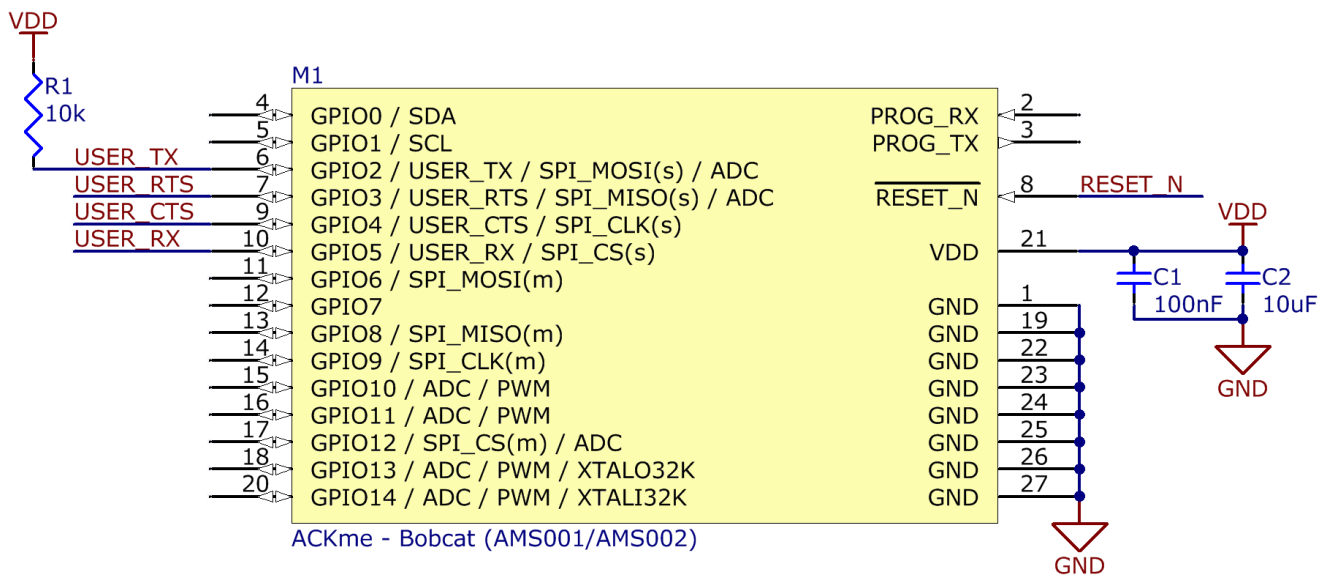

Note: The 10K pullup resistor on pin 6 allows the module to go to sleep and stay asleep. It also enables sleep current to be reduced to a typical value of 1.65uA. If pin 6 is not driven high the wake-up circuit may be highly sensitive to small variations in capacitance or voltage on module pins. Module sleep current may also remain higher, at around 200uA.

6.6 Operation using TruConnect

The information in this section provides a very brief overview of basic operation using TruConnect. For detailed information, consult the TruConnect Reference Guide available online at <http://truconnect.ack.me>

6.6.1 Bootup Configuration

At boot up, TruConnect attempts to load saved configuration settings i.e. the saved state of TruConnect variables. There are three configuration sets that may be loaded, depending on the state of the module. User

settings may be saved/changed as required, Factory Settings may be saved only once, and Default settings are hardcoded into the app at compile time and cannot be changed. Configuration load at boot time occurs in the following sequence:

1. **User Settings.** This configuration is set by a user and saved by the TruConnect `save` command without any supplied arguments. User configuration can be changed at any time, and the configuration is deleted when a factory reset is performed. If no user configuration is present or it is corrupted then TruConnect attempts to load the factory settings.

2. **Factory Settings.** Factory configuration provides a way to save a configuration at manufacturing time. Factory settings are saved using the TruConnect command:

```
save factory <BD_ADDR>
```

Save with the `lock` option to ensure that factory settings cannot be overwritten:

```
save factory <BD_ADDR> lock
```

CAUTION! The factory configuration cannot be changed after saving with the `lock` option.

If no factory configuration is present or it is corrupted, then TruConnect loads the basic compile-time default configuration.

3. **Default Settings.** The default configuration is a sane set of defaults that are hardcoded in TruConnect.

6.6.2 Factory Reset

The module may be factory reset with a TruConnect command, or by asserting the factory reset pin at bootup.

To factory reset via a command, issue:

```
> fac <BD_ADDR>
```

To factory reset via the factory reset GPIO:

1. Identify the GPIO used for factory reset by issuing the command to get GPIO usage: `get gp u` (the factory reset default is GPIO 6).
2. Assert a logic 1 (high) on the pin associated with the factory reset GPIO
3. Assert and de-assert the reset pin to force the module to reboot
4. Wait at least 10 seconds (the status of factory reset is printed to the User UART)
5. De-assert the factory reset pin

6.6.3 Command and Stream Mode

The module boots into serial bus command mode by default and accepts configuration and control commands via the User UART. Once the configuration is saved, stream mode may be used to transfer data between the serial interface and a remote device connected to the Bluetooth LE wireless interface. To toggle between command mode and stream mode, the GPIO alternate function `mode_sel` may be used (if config-

ured), or to simply transition from command mode to stream mode, use the `str` command.

Once in stream mode, characters received from a host MCU on the serial interface are automatically transmitted to a remotely connected device via the BLE wireless interface, and characters received from a remotely connected device on the BLE wireless interface are seamlessly transmitted on the serial interface to the host MCU.

Configuration of the module is also possible using a remotely connected application, however if the serial interface is configured to use command mode, remote applications are forbidden from accessing the command interface. To grant a remote application access to the command interface, the serial interface must first place the module into stream mode to signal that it no longer requires access to the command parser.

6.6.4 GPIO Configuration & Usage

The default GPIO configuration of the module is shown in the following list, obtained by issuing the TruConnect command sequence `get gp u`. The User UART, factory reset and I2C pins are configured by default. All other pins are unassigned or reserved.

```
> get gp u
! # Description
# 0 i2c_sda
# 1 i2c_scl
# 2 user_tx
# 3 none
# 4 none
# 5 user_rx
# 6 none,factory
# 7 reserved
# 8 none
# 9 none
# 10 none
# 11 none
# 12 none
# 13 none
# 14 none
```

To configure a GPIO pin for use, the pin must be assigned a function. A large range of functions is available, please refer to the TruConnect reference guide online (at the following link) for further information: <http://truconnect.ack.me/commands#gfu>

7 Regulatory Certification

The AMS00x family of modules has been certified for operation in various regulatory domains. This section outlines certification information specific to the following countries and regions:

- United States
- Canada
- Europe
- Australia
- New Zealand

Should you require regulatory certification for the AMS00x module in a country or region not listed, please contact your local ACKme Networks sales office or create a support request via our website at <http://ack.me/contact>.

7.1 United States

The ACKme Networks AMS-00x module has received Federal Communications Commission (FCC) CFR47 Telecommunications, Part 15 Sub-part C “Intentional Radiators” modular approval in accordance with Part 15.212 Modular Transmitter approval. Modular approval allows the end user to integrate the AMS-00x module into a finished product without obtaining subsequent and separate FCC approvals for intentional radiation, provided no changes or modifications are made to the module circuitry. Changes or modifications could void the user’s authority to operate the equipment. The end user must comply with all of the instructions provided by the Grantee which indicate installation and/or operating conditions necessary for compliance.

The finished product is required to comply with all applicable FCC equipment authorization, regulations, requirements, and equipment functions not associated with the transmitter module portion. For example, compliance must be demonstrated to regulations for other transmitter components within the host product; to requirements for unintentional radiators (Part 15 Sub-part B “Unintentional Radiators”), such as digital devices, computer peripherals, radio receivers, etc.; and to additional authorization requirements for non-transmitter functions on the transmitter module (i.e. Verification, or Declaration of Conformity) (e.g., transmitter modules may also contain digital logic functions) as appropriate.

7.1.1 Labeling and User Information Requirements

The AMS-00x module has been labelled with a unique FCC ID number, and if the FCC ID is not visible when the module is installed inside another device, then the outside of the finished product into which the module is installed must also display a label referring to the enclosed module. This exterior label can use wording as follows:

Contains FCC ID: 2ABPY-BB4EA - Model No: AMS001
2ABPY-0D06E - Model No: AMS002

This device complies with Part 15 of the FCC Rules. Operation is subject to the following two conditions: (1) this device may not cause harmful interference, and (2) this device must accept any interference received, including interference that may cause undesired operation.

The user manual for the product should include the following statement:

This equipment has been tested and found to comply with the limits for a Class B digital device, pursuant to part 15 of the FCC Rules. These limits are designed to provide reasonable protection against harmful interference in a residential installation. This equipment generates, uses and can radiate radio frequency energy and if not installed and used in accordance with the instructions, may cause harmful interference to radio communications. However, there is no guarantee that interference will not occur in a particular installation. If this equipment does cause harmful interference to radio or television reception, which can be determined by turning the equipment off and on, the user is encouraged to try to correct the interference by one or more of the following measures:

- Reorient or relocate the receiving antenna.
- Increase the separation between the equipment and receiver.
- Connect the equipment into an outlet on a circuit different from that to which the receiver is connected.
- Consult the dealer or an experienced radio/TV technician for help.

Additional information on labeling and user information requirements for Part 15 devices can be found in KDB Publication 784748 available at the FCC Office of Engineering and Technology (OET) Laboratory Division Knowledge Database (KDB) at the following website: <https://apps.fcc.gov/oetcf/kdb/index.cfm>

7.1.2 RF Exposure

All transmitters regulated by FCC must comply with RF exposure requirements. OET Bulletin 65, Evaluating Compliance with FCC Guidelines for Human Exposure to Radio Frequency Electromagnetic Fields, provides assistance in determining whether proposed or existing transmitting facilities, operations or devices comply with limits for human exposure to Radio Frequency (RF) fields adopted by the Federal Communications Commission (FCC). The bulletin offers guidelines and suggestions for evaluating compliance.

If appropriate, compliance with exposure guidelines for mobile and unlicensed devices can be accomplished by the use of warning labels and by providing users with information concerning minimum separation distances from transmitting structures and proper installation of antennas.

The following statement must be included as a CAUTION statement in manuals and OEM products to alert users of FCC RF exposure compliance:

To satisfy FCC RF Exposure requirements for mobile and base station transmission devices, a separation distance of 20 cm or more should be maintained between the antenna of this device and persons during operation. To ensure compliance, operation at closer than this distance is not recommended. The antenna(s) used for this transmitter must not be co-located or operating in conjunction with any other antenna or transmitter

If the AMS-00x module is used in a portable application (i.e., the antenna is less than 20 cm from persons during operation), the integrator is responsible for performing Specific Absorption Rate (SAR) testing in accordance with FCC rules 2.1091.

7.1.3 External Antenna

Modular approval in the United States is permitted with the use of the integrated antenna ONLY. If an external antenna is used with the AMS-00x module, additional testing of the end product is needed to meet FCC requirements.

7.1.4 Further Information

Additional information regarding FCC certification and use of the AMS-00x module in the United States is available from the following sources.

- Federal Communications Commission (FCC) <http://www.fcc.gov.au>
- FCC Office of Engineering and Technology (OET) Laboratory Division Knowledge Database (KDB) <http://apps.fcc.gov/oetcf/kdb/index.cfm>

7.2 Canada

The AMS-00x module has been certified for use in Canada under Industry Canada (IC) Radio Standards Specification (RSS) RSS-210 and RSSGen. Modular approval permits the installation of a module in a host device without the need to recertify the device.

7.2.1 Labeling and User Information Requirements

Labeling Requirements for the Host Device (from Section 3.2.1, RSS-Gen, Issue 3, December 2010): The host device shall be properly labeled to identify the module within the host device.

The Industry Canada certification label of a module shall be clearly visible at all times when installed in the host device, otherwise the host device must be labeled to display the Industry Canada certification number of the module, preceded by the words “Contains transmitter module”, or the word “Contains”, or similar wording expressing the same meaning, as follows:

Contains transmitter module IC: 11685A-0D06E

User Manual Notice for License-Exempt Radio Apparatus (from Section 7.1.3 RSS-Gen, Issue 3, December 2010): User manuals for license-exempt radio appa-

ratus shall contain the following or equivalent notice in a conspicuous location in the user manual or alternatively on the device or both:

This device complies with Industry Canada license-exempt RSS standard(s). Operation is subject to the following two conditions: (1) this device may not cause interference, and (2) this device must accept any interference, including interference that may cause undesired operation of the device.

Le présent appareil est conforme aux CNR d'Industrie Canada applicables aux appareils radio exempts de licence. L'exploitation est autorisée aux deux conditions suivantes: (1) l'appareil ne doit pas produire de brouillage, et (2) l'utilisateur de l'appareil doit accepter tout brouillage radioélectrique subi, même si le brouillage est susceptible d'en compromettre le fonctionnement.

Transmitter Antenna Notification (from Section 7.1.2 RSS-Gen, Issue 3, December 2010): User manuals for transmitters shall display the following notice in a conspicuous location:

Under Industry Canada regulations, this radio transmitter may only operate using an antenna of a type and maximum (or lesser) gain approved for the transmitter by Industry Canada. To reduce potential radio interference to other users, the antenna type and its gain should be so chosen that the equivalent isotropically radiated power (EIRP) is not more than that necessary for successful communication.

Conformément à la réglementation d'Industrie Canada, le présent émetteur radio peut fonctionner avec une antenne d'un type et d'un gain maximal (ou inférieur) approuvé pour l'émetteur par Industrie Canada. Dans le but de réduire les risques de brouillage radioélectrique à l'intention des autres utilisateurs, il faut choisir le type d'antenne et son gain de sorte que la puissance isotrope rayonnée équivalente (p.i.r.e.) ne dépasse pas l'intensité nécessaire à l'établissement d'une communication satisfaisante.

The above notice may be affixed to the device instead of displayed in the user manual.

User manuals for transmitters equipped with detachable antennas shall also contain the following notice in a conspicuous location:

This radio transmitter (identify the device by certification number, or model number if Category II) has been approved by Industry Canada to operate with the antenna types listed below with the maximum permissible gain and required antenna impedance for each antenna type indicated. Antenna types not included in this list, having a gain greater than the maximum gain indicated for that type, are strictly prohibited for use with this device.

Le présent émetteur radio (identifier le dispositif par son numéro de certification ou son numéro de modèle s'il fait partie du matériel de catégorie I) a été approuvé par Industrie Canada pour fonctionner avec les types d'antenne énumérés ci-dessous et ayant un gain admissible maximal et l'impédance requise pour chaque type d'antenne. Les types d'antenne non inclus dans cette liste, ou dont le gain est supérieur au gain maximal indiqué, sont strictement interdits pour l'exploitation de l'émetteur.

Immediately following the above notice, the manufacturer shall provide a list of all antenna types approved for use with the transmitter, indicating the maximum permissible antenna gain (in dBi) and required impedance for each.

7.2.2 External Antenna Types

Transmitter Antenna (from Section 7.1.2 RSS-Gen, Issue 3, December 2010):

The AMS-00x module can only be operated with the on-board antenna with which it was approved without additional testing.

If an external antenna is used with the AMS-00x module, additional testing of the end product is needed to meet IC requirements as described in the previous section.

7.2.3 Further Information

Additional information may be obtained from the Industry Canada website at <http://www.ic.gc.ca>

7.3 Europe

The AMS-00x module is an R&TTE Directive assessed radio module that is CE marked and has been manufactured and tested with the intention of being integrated into a final product.

The AMS-00x module has been tested to R&TTE Directive 1999/5/EC Essential Requirements for Health and Safety Article 3.1(a), Electromagnetic Compatibility (EMC) Article 3.1(b), and Radio Article 3.2 and the results are summarized in Table 12. A Notified Body Opinion has also been issued. All AMS-00x test reports are available on the ACKme Networks website at <http://ack.me/contact>.

The R&TTE Compliance Association provides guidance on modular devices in the document titled Technical Guidance Note 01 available on the website at http://www.rtteca.com/html/download_area.htm.

NOTE: To maintain conformance to the testing listed in Table 12, the module shall be installed in accordance with the installation instructions in this data sheet and shall not be modified.

When integrating a radio module into a completed product the integrator becomes the manufacturer of the final product and is therefore responsible for demonstrating compliance of the final product with the essential requirements of the R&TTE Directive.

7.3.1 Labeling and User Information Requirements

The label on the final product which contains the AMS-00x module must follow CE marking requirements. The R&TTE Compliance Association Technical Guidance Note 01 provides guidance on final product CE marking

7.3.1 External Antenna Requirements

From R&TTE Compliance Association document Technical Guidance Note 01:

Provided the integrator installing an assessed radio module with an integral or specific antenna and installed in conformance with the radio module manufacturer's installation instructions requires no further

evaluation under Article 3.2 of the R&TTE Directive and does not require further involvement of an R&TTE Directive Notified Body for the final product. [Section 2.2.4]

The European Compliance Testing listed in Table 12 was performed using the AMS-00x on-board antenna.

7.3.2 Further Information

A document that can be used as a starting point in understanding the use of Short Range Devices (SRD) in Europe is the European Radio Communications Committee (ERC) Recommendation 70-03 E, which can be downloaded from the European Radio Communications Office (ERO) at: <http://www.ero.dk>.

Further information may be obtained from the following websites:

- Radio and Telecommunications Terminal Equipment (R&TTE)
http://ec.europa.eu/enterprise/rtte/index_en.htm
- European Conference of Postal and Telecommunications Administrations (CEPT)
<http://www.cept.org>
- European Telecommunications Standards Institute (ETSI)
<http://www.etsi.org>
- European Radio Communications Office (ERO)
<http://www.ero.dk>
- The Radio and Telecommunications Terminal Equipment Compliance Association (R&TTE CA)
<http://www.rtteca.com/>

Table 12. European Compliance Testing
AMS001

Certification	Standard	Article	Laboratory	Report Number	Date
Safety	EN 60950-1:2006 + A11:2009 + A1:2010 + A12:2011	3.1(a)	Shenzhen Morlab Communications Technology Co., Ltd.	SZ15010120A01	2015-Feb-09
Health	EN 50371:2002-03			SZ15010120S01A	2015-Feb-09
EMC	EN 301 489-1 v1.9.2 (2011-09)	3.1(b)		SZ15010120E01A	2015-Feb-09
	EN301 489-17 v2.2.1 (2012-09)				
Radio	EN 300 328 v1.8.1 (2012-06)	3.2		SZ15010120W04A	2015-Feb-09
Notified Body Opinion	CE 0700	-	PHOENIX TESTLAB	15-110950	2015-Feb-13

AMS002

Certification	Standard	Article	Laboratory	Report Number	Date
Safety	EN 60950-1:2006+A11:2009+A1:2010	3.1(a)	Shenzhen Morlab Communications Technology Co., Ltd.	SZ14100103A01	2015-Jan-07
Health	EN 50371:2002-03			SZ14100103S01A	2015-Jan-04
EMC	EN 301 489-1 v1.9.2 (2011-09)	3.1(b)		SZ14100103E01	2014-Nov-11
	EN301 489-17 v2.2.1 (2012-09)				
Radio	EN 300 328 v1.8.1 (2012-06)	3.2		SZ14100103W04	2015-Jan-06
Notified Body Opinion	CE 0700	-	PHOENIX TESTLAB	15-110130	2015-Jan-12

7.4 Australia

Australian radio regulations do not provide a modular approval policy similar to the United States (FCC) and Canada (IC). However, AMS-00x module test reports may be used in part to demonstrate compliance in accordance with ACMA Radio communications “Short Range Devices” Standard 2004 which references Australia/New Zealand industry standard AS/NZS-4268:2012. AMS-00x RF transmitter test reports may be used as part of the product certification and compliance folder. For further information regarding the availability of RF test reports, please contact ACKme Networks via our website at <http://ack.me/contact>.

7.4.1 External Antenna Requirements

The compliance test reports provided in Table 12 were performed using the AMS-00x on-board antenna. If an

external antenna is used with the AMS-00x module, additional testing of the end product is needed to meet Australian regulatory requirements.

7.4.2 Further Information

Additional information may be obtained from the Australian Communications and Media Authority website at <http://www.acma.gov.au>.

7.5 New Zealand

New Zealand radio regulations do not provide a modular approval policy similar to the United States (FCC) and Canada (IC). However, AMS-00x module test reports may be used in part to demonstrate compliance with the New Zealand “General User Radio License for Short Range Devices”. New Zealand Radio communications (Radio Standards) Notice 2010 references Australia/New Zealand industry standard AS/NZS-4268:2012. AMS-00x RF transmitter test reports may be used as part of the product certification and compliance folder. For further information regarding the availability of RF test reports, please contact ACKme Networks via our website at <http://ack.me/contact>.

7.5.1 External Antenna Requirements

The compliance test reports provided in Table 12 were performed using the AMS-00x on-board antenna. If an external antenna is used with the AMS-00x module, additional testing of the end product is needed to meet New Zealand regulatory requirements.

7.5.2 Further Information

Additional information may be obtained from the New Zealand Radio Spectrum Ministry of Economic Development website at <http://www.rsm.govt.nz>.

8 Packaging, Handling & Storage, RoHS

8.1 Packaging

AMS00x modules are shipped in an ESD bag.

AMS00x modules are also available in reels each containing 1000 modules. Reels are shipped in an ESD and moisture resistant sealed bag. The shelf life of the sealed bag is 12 months at 40°C and <90% Relative Humidity (RH). Please refer to the bag seal date.

8.2 Tape and Reel Specifications

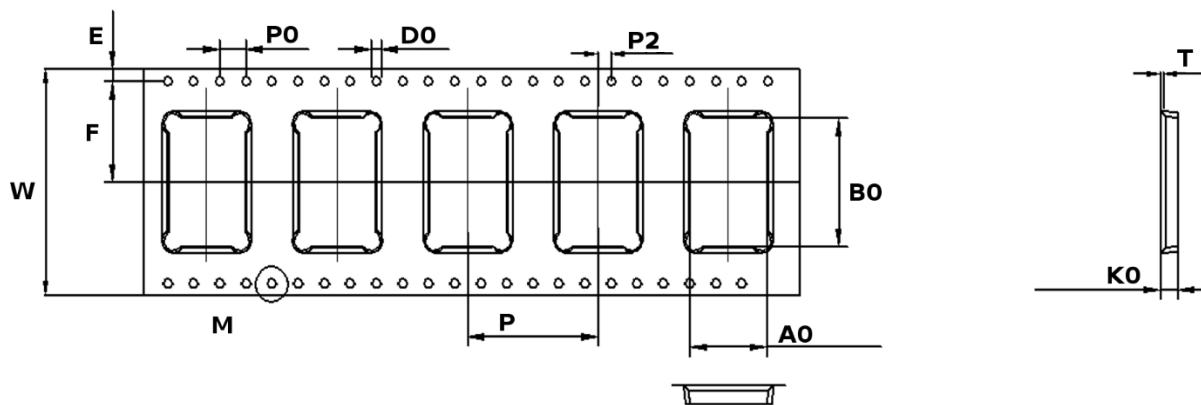

Figure 7 - Tape Specifications

Symbol	A0	B0	D0	E	F	KO
Specification (mm)	11.8 ± 0.10	18.1 ± 0.10	1.5 ± 0.10	1.75 ± 0.10	14.2 ± 0.10	2.70 ± 0.10

Symbol	P	P0	P2	T	W
Specification (mm)	20.0 ± 0.10	4.00 ± 0.10	2.00 ± 0.10	0.30 ± 0.05	32.0 ± 0.30

- Tape material : black PS material, in line with ROHS environmental management substances
- Tape thickness: $0.3 \text{ mm} \pm 0.05 \text{ mm}$
- Tape width: 32mm (1.3")
- Protection zone: black PS material
- Distance between chain hole centers within the range of $\pm 0.2 \text{ mm}$ of cumulative error
- Anti-camber at 1 mm / 250 mm
- All dimensions in line with the requirements of EIA-481-D

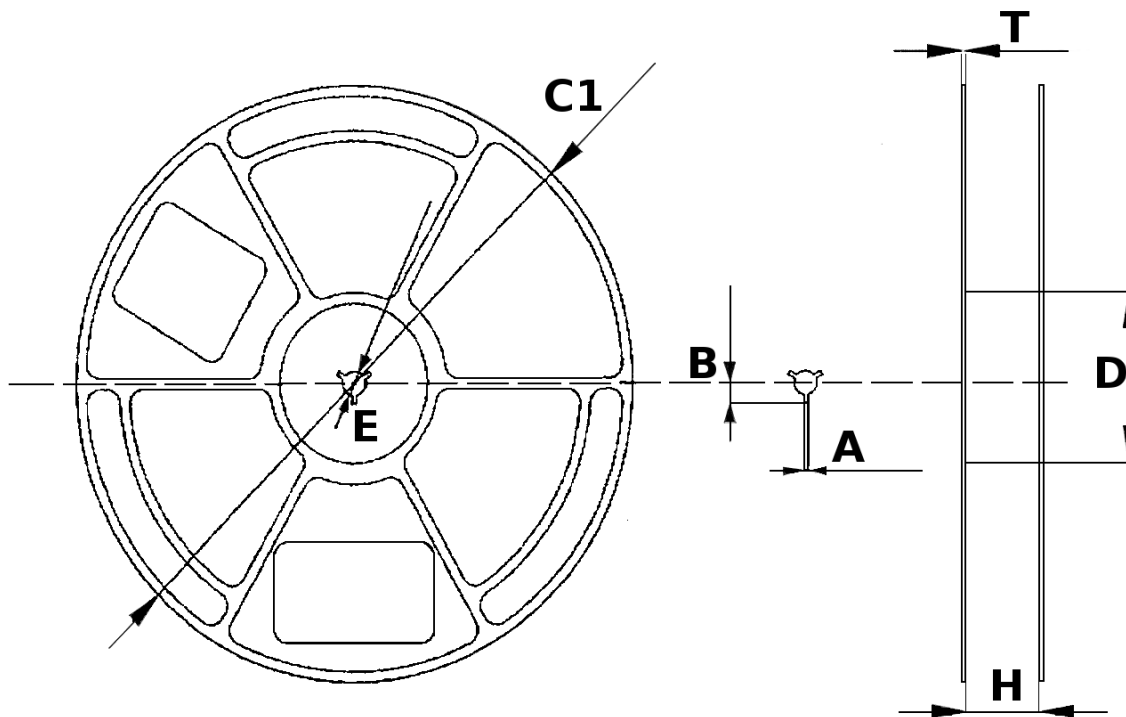

Figure 8 - Reel Specifications

Symbol	A	B	C1	D	E	H	T
Specification (mm)	2.5 ± 0.2	11 ± 0.2	330 ± 1	99.5 ± 0.1	13.2 ± 0.2	$32.8 + 0.3 / -0.2$	2.25 ± 0.2

8.3 Handling & Storage



CAUTION MSL3 Sensitive Device!

AMS00x modules are moisture sensitive devices rated at Moisture Sensitive Level 3 (MSL3) per **IPC/JEDEC J-STD-20**.

After opening the moisture sealed storage bag, modules that will be subjected to reflow solder or other high temperature processes must be:

1. mounted to a circuit board within 168 hours at factory conditions ($\leq 30^{\circ}\text{C}$ and $< 60\% \text{ RH}$)

OR

2. continuously stored per **IPC/JEDEC J-STD-033**

Modules that have been exposed to moisture and environmental conditions exceeding packaging and storage conditions **MUST** be baked before mounting according to **IPC/JEDEC J-STD-033**.

Failure to meet packaging and storage conditions will result in irreparable damage to modules during solder reflow.

8.4 RoHS Directive

Each AMS00x module is produced according to the RoHS (Restriction of the use of certain Hazardous Substances in electrical and electronic equipment) directive and complies with the directive.



9 Ordering Information

AMS00x modules are available individually or in a reel of 1000 units as described in the tables below.

Table 13. AMS001 Ordering Information

Part Number	Description
AMS001/S	1 x AMS001 module with TruConnect pre-installed. Each module is individually packaged in an ESD bag.
AMS001/R	A single reel containing 1000 x AMS001 modules, each with TruConnect pre-installed. The entire reel is packaged in an ESD and MSL3-rated moisture sensitive bag.

Table 14. AMS002 Ordering Information

Part Number	Description
AMS002/S	1 x AMS002 module with TruConnect pre-installed. Each module is individually packaged in an ESD bag.
AMS002/R	A single reel containing 1000 x AMS002 modules, each with TruConnect pre-installed. The entire reel is packaged in an ESD and MSL3-rated moisture sensitive bag.

10 Revision History & Glossary

10.1 Revision History

Table 15: Document Revision History

Revision	Date	Change Description
ADS-MS00x-100R	10-Nov-2014	Initial version
ADS-MS00x-101R	7-Jan-2015	Note minimum boot voltage Add packaging section
ADS-MS00x-102R	2-Feb-2015	Note pull-up requirement and minimum deep sleep current
ADS-MS00x-103R	2-Feb-2015	Finalized AMS002 CE regulatory information for AMS002
ADS-MS00x-104R	8-Apr-2015	Added limits for IO pins Finalized AMS001 regulatory information
ADS-MW00x-105R	9-Jun-2015	Updated GPIO and pin definitions in Pin and Signal Descriptions
ADS-MW00x-106R	28-Aug-2015	Added maximum voltage details for Input and Output Pins Added vias diagram to Routing Recommendations Added tape and reel documentation. Removed tray packaging details.
ADS-MW00x-107R	14-Sep-2015	Added Adaptive Frequency Hopping to features and description.

10.2 Glossary

In most cases, acronyms and abbreviations are defined on first use. A comprehensive list of acronyms and other terms used in ACKme Networks documents are provided on the ACKme Networks website at <http://ack.me/FAQs/Glossary>.

ACKme reserves the right to make changes without further notice to any products or data herein to improve reliability, function, or design. Information furnished by ACKme is believed to be accurate and reliable. However, ACKme does not assume any liability arising out of the application or use of this information, nor the application or use of any product described herein, neither does it convey any license under its patent rights nor the rights of others.

ACKme Networks

20 North Santa Cruz Ave
Los Gatos CA 95030
United States

© 2014-2015 ACKme Networks Inc. All rights reserved.

ADS-MS00x-107R • Preliminary Data Sheet
September 14, 2015

Contact Information

+1 (408) 402 8160

<http://ack.me/contact>

